 **KNIKMOPS**
ENGINEERED TO PERFORM

KM 140

TECHNISCHE GEGEVENS



**GEBROEDERS
GEENS**

POWERFULL INNOVATIONS

Gebroeders Geens NV

Industriezone De Kluis
Hinnenboomstraat 5
2320 Hoogstraten, België

T: +32 (0)3 314 79 30
T: +32 (0)3 297 29 30

info@knikmops.be
www.knikmops.be

KM 140

KM140

KM140TE

mm	Wielbasis	A	1600	1700
mm	Totale lengte zonder bak	B	2810	2960
mm	Totale lengte met bak	C	3490	3640
mm	Totale breedte	D	950/1350	950/1350
mm	Breedte bak	E	1000/1350	1000/1350
°	Maximale draaihoek	F	47	47
mm	Draaicirkel buitenkant	G	2500	2500
mm	Hoogte Rolbeugel /Hoogte ROPS-FOPS	H	2170/2260	2170/2260
mm	Zithoogte	I	1270	1270
mm	Bodemvrijheid	J	315	315
°	Inkiephoek vanaf grondvlak	K	30	30
mm	Hoogte giek-scharnier	L	1230	1320
mm	Overlaadhoogte	M	1975	2420/3030
mm	Max. hoogte scharnier aanpik	N	2145	2590/3200
L	Inhoud brandstoftank		40	40
	Type dieselmotor (Yanmar)		3TNV88C	3TNV88C
kw/pk	Motorvermogen		27.5/37	27.5/37
	Aantal cilinders		3	3
	Aandrijfhydrauliek		plunjerpomp	plunjerpomp
	Wiel aandrijving		plunjer motor	plunjer motor
L/min	Debiet werkhydrauliek		48	48
bar	Werkdruk hydrauliek		180	180
kg	Rijklar gewicht zonder hulpstuk		1550	1750
kg	Hefkracht		1150	925
kg	Uitbreekkracht		955	1025
km/h	Rijsnelheid		20	20

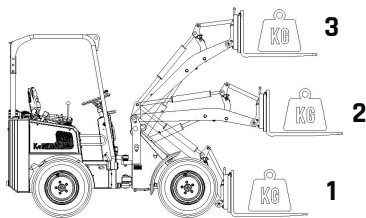
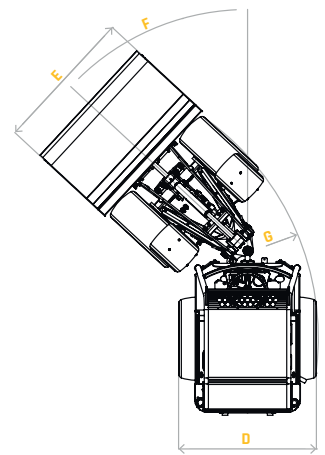
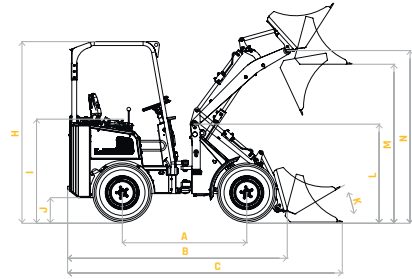

	1	2	3
KM 140 niet geknikt	1600	1155	940
KM 140 TE niet geknikt Telescooparm ingeschoven	1300	980	540
KM 140 TE niet geknikt Telescooparm uitgeschoven	760	600	450

Gegevens onder voorbehoud Gebroeders Geens (08-2021)

